



## Custom Dynamics® Spyder® HMT Brake Light Installation Instructions

We thank you for purchasing the Custom Dynamics® Spyder® RT HMT LED Brake Light. Our products utilize the latest technology and high quality components to ensure you the most reliable service. We offer one of the best warranty programs in the industry and we back our products with excellent customer support, if you have questions before or during installation of this product please call Custom Dynamics® at 1(800) 382-1388.

**Part Number: SPY-RT-HMT**

### Package Contents:

- HMT LED Assembly (1)
- Connector Harness (1)
- Wire Guide Tool (1)
- Adhesive Primer

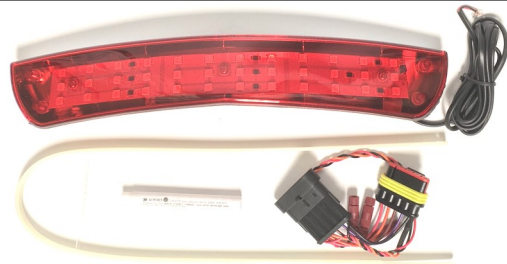

Fits: 2010-2019 RT, RT-S, RT-Limited Models



# ATTENTION

Please read all Information below before Installation

**Warning:** Disconnect negative battery cable from battery; refer to owner's manual. Failure to do so may result in electrical shock, injury, or fire. Secure negative battery cable away from positive side of battery and all other positive voltage sources on vehicle.

**Safety First:** Always wear appropriate safety gear including safety glasses when performing any electrical work. It is highly recommended that safety glasses be worn throughout this installation process. Be sure vehicle is on level surface, secure and cool.

**Important:** This product is designed and intended for use as auxiliary lighting only. It is NOT intended to replace any original equipment lighting installed on the vehicle and should not be used for that purpose. This product must be wired so that it does not interfere with any original equipment lighting.

**Note:** Some wiring knowledge may be needed for this installation. Consult your vehicle detailed service manual for wiring information and color codes. Use a meter or test light to verify wiring before tapping any vehicle wiring. If the steps contained within are beyond your skillset, do not attempt installation, contact a qualified mechanic or dealership to assist you.

**Important:** It is recommended to perform this installation in a controlled environment of 65 degrees F or higher and allow 24 hours for the tape to bond completely before washing or operating the vehicle.

**Note:** Adhesive Primer is classified as a sensitive chemical and cannot be shipped by Air or international. Custom Dynamics may not be able to ship promotor with orders in these cases, and will be removed from package.

### Installation

# 1

Remove outer trunk cover by unscrewing the 6 Torx screws on inside of trunk lid.



# 2

Drill 3/16 hole in outer cover in lower right corner of the indent area of cover for wires to pass through. Note location of wire exiting from HMT unit to make sure your hole is in the proper location.

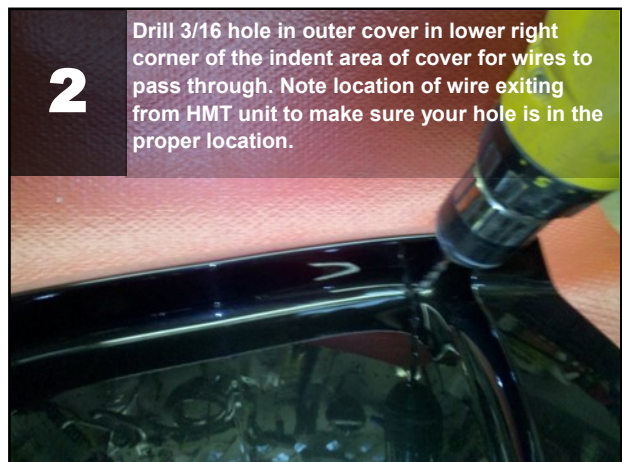

Questions? Call us at: 1 (800) 382-1388 M-TH 8:30AM-5:30PM / FR 9:30AM-5:30PM EST

## Installation Instructions - Page 2

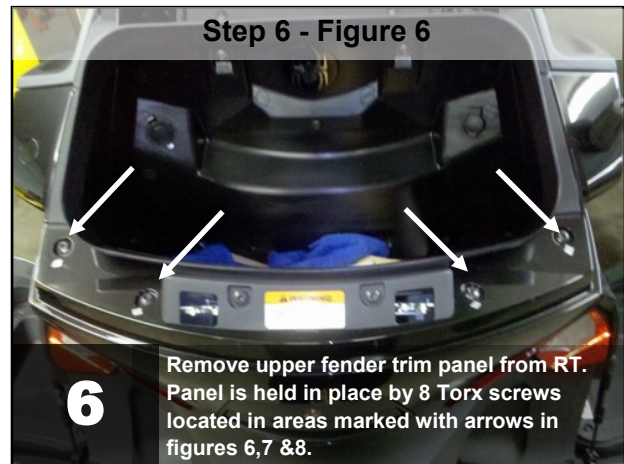
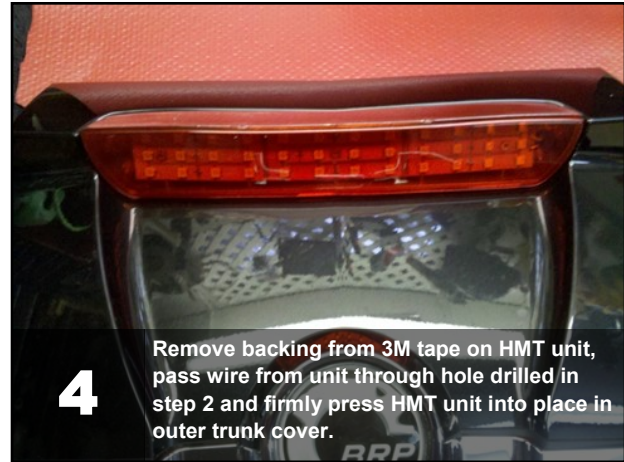



## Installation Instructions - Page 3

7

With the trim panel removed locate the 5 pin tail light connector on right side of RT and unplug it being careful to keep track of both ends.  
**NOTE:** If you are unable to locate the connector, refer to the **TAILLIGHT ASSEMBLY REMOVAL** instructions at the bottom of the page.

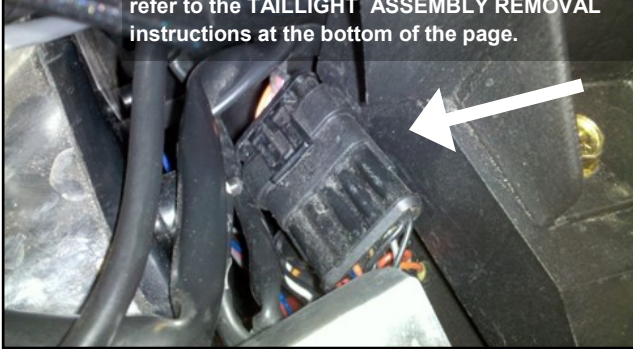

8

Plug HMT harness from kit in between these connectors as shown, keeping long lead from this harness free.



9

Using wire guide tool from kit, insert tool in between outer trunk side trim panel and into opening for right side hinge.



10

Insert wire from HMT unit in hole in wire tool and pull wire tool back towards outside panel so wire is now between outer panel and inner hinge opening.

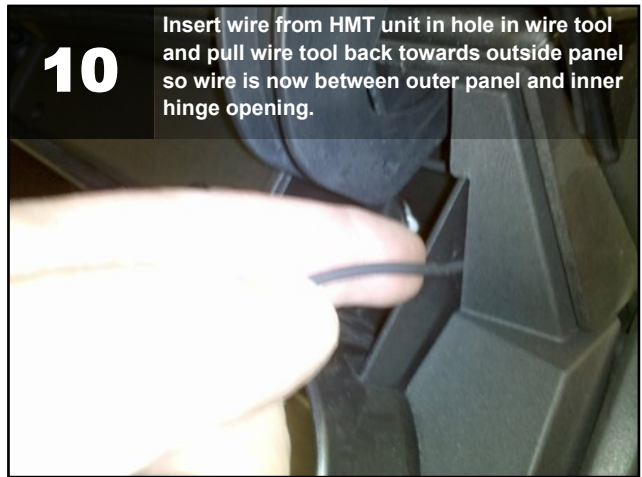

11

Just above right side tail light, locate hole where wires and antenna cable pass upward towards trunk. Insert wire tool in this opening pushing upward until tool is visible between outer panel and trunk hinge.



12

Insert wire from HMT unit into wire tool and pull wire back down until it emerges from opening above right side tail light.



**TAILLIGHT ASSEMBLY REMOVAL:** Using a flat screwdriver, disconnect the holding clip on top of the gas shocks on both saddlebags. Remove the two torx screws from both sides that were covered by the gas shocks on the back of the rear fender (the large black panel across the back) remove the three torx screws from the top of the fender. Note: these three screws are shorter than the other screws and should be kept separate. Rotate the rear fender down until it stops on the rear tire. The rear fender does not need to be completely removed. Using a T27 torx driver, remove the three screws holding the taillight assembly.

Questions? Call us at: 1 (800) 382-1388 M-TH 8:30AM-5:30PM / FR 9:30AM-5:30PM EST

# Installation Instructions - Page 4



= Posi-Lock™ Connections

## Step 13 - Installing the dual converter

1. The 3 wire side of the Dual converter connects to the 3 Posi-Lock™ connectors on the Harness color for color. Unscrew the empty side of the connector and insert the wire, then attach red to red, orange to orange, and black to black. (See diagram)
2. The 2 wire side of the dual converter connects to the HMT brake light with the included Posi-Lock™ connectors. Match colors, black goes to black and red to red. (See diagram)
3. Test operation of the HMT Brake Light in all modes, running, brake, left turn and right turn.

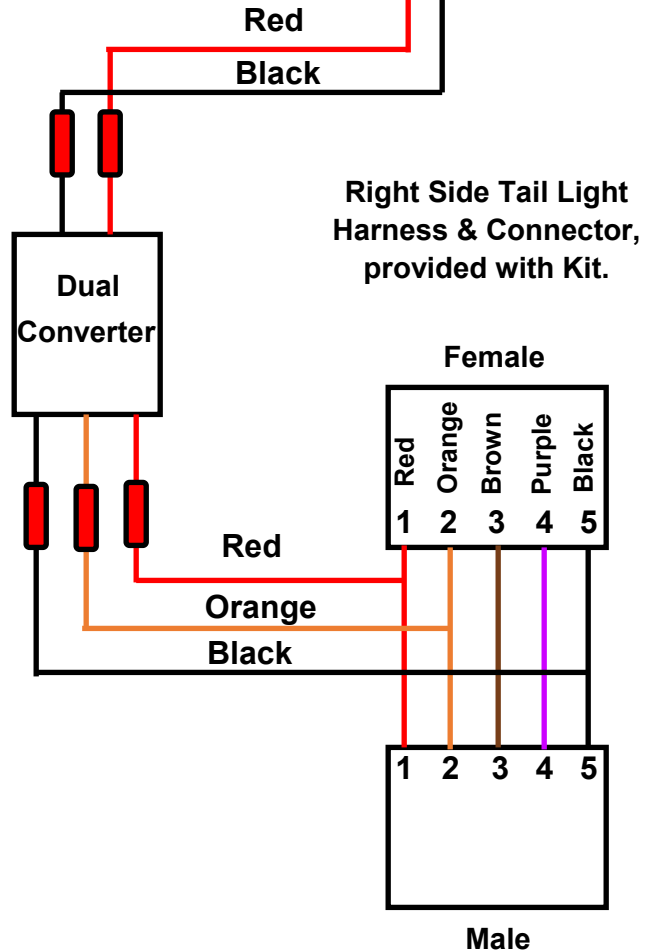

## Step 14

1. Reinstall the fender trim panels you removed in step 6.

